



CaféTO

CURB LANE CAFÉ GUIDELINES 2025

1. PROGRAM OVERVIEW p.4

Important information

Program Goals

2. APPLICATION AND REGISTRATION p.6

Who can apply?

Application checklist

3. FEES p.10

Application Fee

Seasonal Permit Fee

Alcohol Service and AGCO

4. CURB LANE CAFÉ TECHNICAL GUIDELINES p.12

What is a curb lane café?

Roadway placement

Temporary accessible platforms

Temporary accessible platforms guidelines

Temporary accessible platforms design drawing technical checklist

Café alignment

Umbrella and canopies

Emergency access

5. ACCESSIBILITY AND CURB LANE CAFÉS p.20

Pedestrian clearway

Café furniture and facilities

Temporary ramps

6. GENERAL REQUIREMENTS AND OPERATOR RESPONSIBILITIES p.23

Lighting

Amplified music and noise

Maintenance, cleanliness and orderliness

Fire and utility access

Waste collection

Use of café space

Heating devices and fire safety

Hours of operation

Removal Authority

APPENDIX p.25

Toronto Fire Services portable heater guidelines

Fueled heating appliances

Toronto Hydro requirements

Utility & Infrastructure clearances

The CaféTO team

NOTE:

Sidewalk cafés require a separate application process. More information about applying for and receiving a sidewalk café permit is available [here](#).

ABOUT THIS GUIDEBOOK

This Guidebook provides guidelines for curb lane cafés for the 2025 café season. These guidelines include the minimum requirements that eating and drinking establishments must meet to obtain a valid curb lane café permit and operate a curb lane café as part of the CaféTO Program.

Applicants are strongly encouraged to read this Guidebook carefully in its entirety when considering applying for a curb lane café, and to refer to it throughout the application process. For additional information, please refer to the CaféTO bylaw, Toronto Municipal Code [Chapter 742](#) Sidewalk Cafés, Parklets and Marketing Displays.

The City of Toronto retains the discretion to review installations in the right-of-way on a case-by-case basis considering factors such as past complaints reported at the address, non-compliance with the CaféTO guidelines and conditions imposed by Community Council in similar local circumstances.

These guidelines are subject to change and cafés are only permitted in accordance with all requirements of the Province of Ontario and the City of Toronto, including statues, bylaws, regulations, orders and guidelines. Keep up to date on requirements by visiting toronto.ca/CafeTO and reviewing this Guidebook regularly.





1.0 PROGRAM OVERVIEW

The CaféTO Program offers local restaurant and bar operators with a valid eating establishment municipal business licence access to public space on city streets to expand their outdoor dining capacity.

Curb lane cafés must meet the design and operational requirements set out in [Chapter 742](#), including but not limited to, obligations related to health and safety, accessibility, equipment (e.g. temporary accessible platforms, ramps and planters), and insurance and indemnification requirements.

The City of Toronto has prepared this guidebook to summarize the essential information required to safely operate curb lane cafés for the 2025 café season.

IMPORTANT INFORMATION



Fees

A one-time application fee and annual permit fees will be charged based on the size of your café. More information on [page 10](#) of this guidebook



Temporary Accessible Platforms

Temporary platforms are required to provide an unobstructed and level surface between the sidewalk and curb lane café. More information on [page 14](#).



Café Alignment

All participants will be allocated curb lane space that aligns with their business frontage, with options to expand. More information on [page 18](#).



Permits

Permits issued for curb lane cafés will be renewable on an annual basis.



PROGRAM GOALS



Complete Streets

Complete Streets are streets that are designed to be safe for all users: people who walk, cycle, take transit or drive, and people of varying ages and levels of ability. They also consider other uses like cafés, street furniture, street trees, utilities, and stormwater management. Complete streets balance a variety of curbside uses for residents, commerce and transit.



Streetscape Vibrancy and Community Benefit

Curb lane cafés transform stretches of roadway into bustling, animated spaces for gathering and leisure. Curb lane cafés can strengthen the neighbourhood's local identity through unique outdoor dining spaces, enhancing the look of Toronto's main streets. Curb lane cafés offer additional opportunities for the local community to engage with their neighbourhood restaurants, and support their local economy.



Economic Benefits

Curb lane cafés attract diners from across the City and beyond, generating increased pedestrian traffic on main streets, inviting people to enjoy all that a neighbourhood has to offer. Expanded outdoor dining options also provide the opportunity for eating and drinking establishments to serve more tables, hire more staff and offer increased seating options to customers during the café season.





2.0 APPLICATION AND REGISTRATION

WHO CAN APPLY?

All eating and drinking establishments with a business licence in good standing and valid insurance may apply and be considered for a curb lane café. Please note, if you participated in the CaféTO program in 2024, you may simply renew your curb lane café permit and do not have to submit a full application.



Eating and drinking establishment operators who wish to operate a curb lane café in 2025 must follow the steps below to participate in the CaféTO Program:

1. Visit toronto.ca/CafeTO to apply for your curb lane café by 11:59 p.m. on February 19, 2025.
2. If your application is acceptable, you will be asked to submit a Certificate of Insurance issued by your insurer for \$2,000,000.00 Commercial General Liability with the City listed as additional insured.
3. After receiving a Traffic Plan from City staff that informs you of your final café size and location, you must develop and submit your Temporary Accessible Platform Package for review. Please see [page 8](#) for more information on what needs to be included.
4. You will be required to pay your application fee, seasonal permit fee and sign a Curb Lane Café Agreement identifying the terms and conditions of the permit. You will receive a renewable Curb Lane Café permit after you pay your fees and submit the signed legal agreement.
5. City staff will communicate when the safety and traffic equipment will be installed for your café permit space.
6. At the end of the season, you will be notified of your curb lane café removal date. All café items, including temporary platforms must be removed from the curb lane by this date.

An application may be refused in accordance with [Chapter 742](#) or if the past conduct of the applicant gives the City reason to believe that they will not operate in accordance with the bylaw.

✓ APPLICATION CHECKLIST

Below is a checklist to help ensure you have a complete curb lane café application. Incomplete or incorrect applications can lead to delays in processing times. All applications must be completed online. There is no option to apply for in-person or over-the-phone. It is the responsibility of the applicant to read this entire guidebook and to be familiar with where a curb lane café may or may not be permitted.

1. CURB LANE CAFÉ APPLICATION

If you did not operate a curb lane café in 2024 and you are a new applicant in 2025, you must submit a complete application online through the [permit portal](#). Your curb lane café application must include:

- Completed and signed **Curb Lane Café Application Form** by the Director/Officer listed on the corporation
- Municipal Business Licence must be valid and in good standing at the time of application
- Indicate the proposed road the curb lane café will be located on
- Indicate the proposed curb lane café length in metres
- One piece of valid government-issued identification for the Director/Officer who appears on the Primary Business Licence will be verified by City staff by virtual appointment or in-person
- Three photos of the proposed café areas
 - View of the front of your property including the full width of your property, the sidewalk and curb lane in front of your property
 - Left view of your property showing the sidewalk and curb lane parallel to the street
 - Right view of your property showing the sidewalk and curb lane parallel to the street
- Have all required documents ready to upload before applying on the [permit portal](#)
- Print or save the Reference Number provided to you after you have submitted your application.

TIP! Photos must show the curb lane area including the view of neighbouring properties. Google Streetview cannot be used.

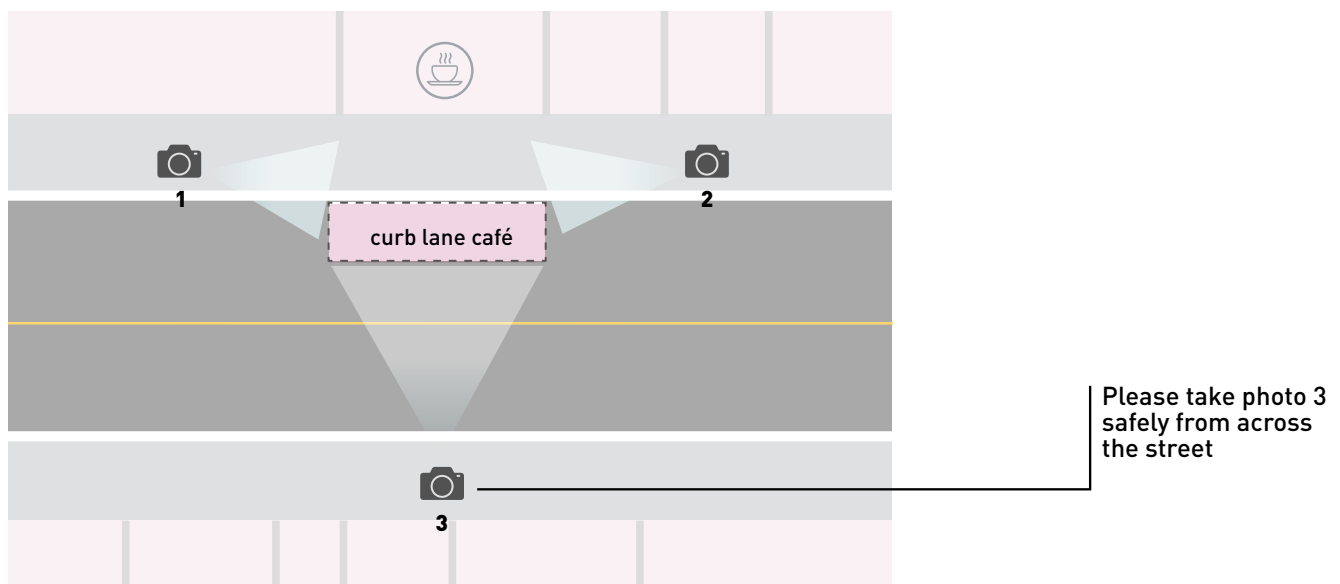

IMPORTANT!

You must apply by 11:59 p.m. on February 19, 2025 to ensure your application for a curb lane café is reviewed and approved by the start of café season. Late applicants will not be accepted.

2. INSURANCE

Once you complete your application, City staff will review your submission to ensure the requirements of Chapter 742 have been met. City staff will also check for outstanding fees or fines, and review your past compliance with other applicable bylaws the Liquor Licence Act and any regulations under any such legislation.

If your application is acceptable, City staff will contact you for the following:

- A completed **Certificate of Insurance form** issued by the insurer and uploaded onto the **permit portal** using your Reference Number and an upload token number provided to you by City staff. Your insurance must be a minimum of \$2,000,000.00 Commercial General Liability (CGL) or comprehensive insurance.

If your application does not meet the requirements of **Chapter 742**, a Notice of Refusal will be issued. You will have 14 calendar days to appeal the decision.

3. TEMPORARY ACCESSIBLE PLATFORM PACKAGE

Detailed, scaled plans and specifications must be submitted to determine if the proposed curb lane café platform meets the requirements set in **Chapter 742**. Your completed Temporary Accessible Platform Package must be e-mailed to cafeto@toronto.ca for City staff to review. Required documentation includes:

- One (1) fully dimensioned platform plan drawing
- One to two (1-2) elevation drawings, which include all vertical barrier dimensions drawings (see page 17 for sample drawing)
- Any additional construction details or drawings as pertinent to the platform design (optional)
- Refer to the Curb Lane Café Technical Guidelines on **page 14** when preparing your drawings.

IMPORTANT!

All temporary platforms must be approved by the City before installation.

All drawings must be stamped/signed by a licensed professional such as an engineer, architect, or BCIN (Building Code Identification Number) licensed designer.

4. PERMIT

Upon approval of your application, City staff will send you your application fee and seasonal permit fee invoice and a Curb Lane Café Agreement identifying the terms and conditions of your permit.

- Application fee and seasonal permit fee to be paid online
- Upload the signed Curb Lane Café Agreement to the [permit portal](#)
- Your Curb Lane Café Permit must be posted on the street door or in the lower front window of the associated establishment throughout the café season, in such a way that it is visible at all times from the public sidewalk

5. INSTALLATION

City staff will notify you of the date when traffic safety equipment will be installed for your café permit space.

- Failure to install your temporary accessible platform by June 1, 2025 may result in enforcement action and/or the revocation of your curb lane café permit

IMPORTANT!

You must not enter the curb lane or install a temporary accessible platform until the City has approved your platform plans and safely closed the curb lane by installing traffic and safety equipment.

6. REMOVAL

You will be notified in September of your curb lane café removal date.

- You must** remove all café items, including tables, chairs, equipment, furnishings, fencing and platforms from the curb lane by this date.
 - Private café items left in the curb lane after this date will be removed and may be disposed of without notice
 - The City may charge the permit holder the cost of removing private items left on the road
 - All restaurant and BIA owned curb lane café elements must be removed by the scheduled removal date in October, as communicated by City staff. This allows for the timely removal of all traffic safety equipment.

REMINDER! Refer to [page 11](#) for more information on Liquor Licensing for your curb lane café.



3.0 FEES

As a standard practice, the City of Toronto charges fees for permanent City programs and for use of the public right of way. CaféTO Program fees have been reintroduced and became effective in 2023.

APPLICATION FEE

In 2025, a one-time (non-refundable), application fee of \$865.00 +HST will be charged when an original application is made. This fee is not charged when a permit is renewed.

Seasonal Curb Lane Café Permit Fees

Seasonal permit fees for curbside cafés are charged annually based on the size (square metres) of a café for an entire season. In 2025, the seasonal permit fees are \$132.42 +HST per square metre (m²).

How do I estimate my 2025 Seasonal Curb Lane Café Permit Fees?

You can estimate your approximate seasonal curbside fee in 2025 by multiplying the 2025 seasonal permit fee per square metre (\$132.42 +HST m²) by your curbside café size (area). Your curbside café size is calculated by multiplying the proposed length of the curbside café space by the width of the curbside café space.

How do I know the length of my café?

To determine the proposed length of the curbside café space, use a measuring tape and measure the frontage of your restaurant. Include the proposed length of your curbside café in your application. You may have the option to expand beyond your frontage if your BIA is participating in the Curbside Café Program, or, if your business is located outside of a BIA. If you are located within a BIA, please **contact your BIA** prior to submitting your application.

CURB LANE CAFÉ SIZE

$$\begin{array}{ccccccc}
 \$ 132.42 & & \text{Proposed Length} & & \text{Width of Curb Lane} & & \text{2025} \\
 +\text{HST} & \times & \text{of Curb Lane Space} & \times & \text{Space} & = & \text{Seasonal Curb Lane} \\
 \text{per square} & & \text{(need to measure)} & & \text{(provided by the City)} & & \text{Café Permit Fee} \\
 \text{metre} & & & & & & \\
 \end{array}$$

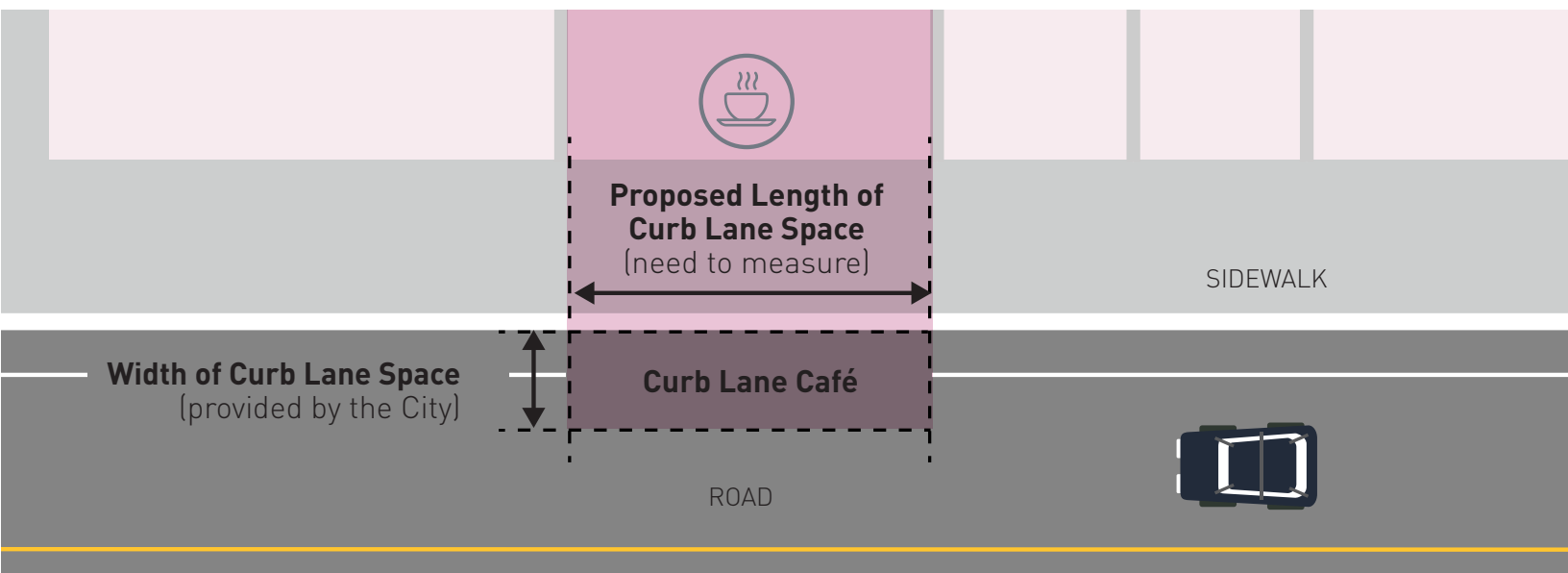

The average width of most curblane café spaces is 1.8 metres, however, exact dimensions will be provided by the City upon receipt of your custom traffic plan.

Example 1: A curblane café with a proposed 12m café length and 1.8m café width

CURBLANE CAFÉ SIZE						
\$ 132.42 +HST per square metre	X	12m Proposed Length of Curblane Space	X	1.8m Provided Width of Curblane Space	=	\$3,232.10 Seasonal Curblane Café Permit Fee

Example 2: A curblane café with a proposed 5.8m café length and 2.5m café width

CURBLANE CAFÉ SIZE						
\$ 132.42 +HST per square metre	X	5.8m Proposed Length of Curblane Space	X	2.5m Provided Width of Curblane Space	=	\$2,169.70 Seasonal Curblane Café Permit Fee

IMPORTANT!

Your final curblane café size will be communicated to you when you receive your Traffic Plan. This will indicate the approved length and width of your curblane space, as well as the exact placement of your café space. The traffic plan is required to begin designing your platform.

Alcohol Service & AGCO

Your CafeTO curblane café permit acts as the City's non-objection to an extension of premises under the conditions of permit (size and permit period). The operator must advise the AGCO representative of their permit. It is the operator's responsibility to ensure compliance with all Alcohol and Gaming Commission of Ontario (AGCO) regulations as well as adhere to any conditions on their liquor sales licence. Restaurant and bar operators wanting to apply for permanent changes to liquor licences will still need to apply for approvals through the [AGCO](#).



4.0 CURB LANE CAFÉ TECHNICAL GUIDELINES

WHAT IS A CURB LANE CAFÉ?

Curb lane cafés are outdoor dining areas located on the street, in a parking lane directly adjacent to a curb. Public safety is the first priority and City staff conduct a detailed review of each application, and install traffic safety materials to close the lane and provide space for the café.

What is NOT considered a curb lane café?

All cafés that are located on the sidewalk are not curb lane cafés. Cafés on private property and any type of café or seating that is on the sidewalk, are not covered by this Guidebook. For more information about sidewalk cafés or patios on private property, please visit the [CaféTO website](#) for more information.



ROADWAY PLACEMENT

Every effort is made to investigate the feasibility of a curb lane closure, but approval cannot be guaranteed. When conducting site reviews, staff consider the streetscape of surrounding your restaurant and may take into account road width, traffic speeds and volumes, non-standard road geometry, or other potential traffic safety concerns.

Curb lane cafés are **NOT** possible within the following areas:

- Parking spaces for persons with disabilities
- Residential permit parking areas (local roads only)
- Passenger loading, bus parking, bus loading, school bus loading zones
- Delivery vehicle and commercial loading zones
- Car-share vehicle parking areas or electric vehicle charging station parking
- Reserved lanes for designated classes of vehicles (e.g. public transit, High Occupancy Vehicle lanes)
- Free parking for restricted periods zones of 30 minutes or less (e.g. day care parking)

Proximity to an intersection limits the ability to close a curb lane to ensure traffic safety and emergency vehicle access. Curb lane cafés are not possible in locations where, in the opinion of the General Manager, Transportation Services, or delegated staff, a curb lane café cannot be safely installed.

Signalized Intersections:

- 30.5 metres of an approaching signalized intersection measured from the closest curb edge of an intersection
- 9 metres beyond a signalized intersection measured from the closest curb edge of an intersection

Un-signalized intersections:

- 15 metres of an approaching un-signalized intersection measured from the closest curb edge of an intersection
- 9 metres beyond an un-signalized intersection measured from the closest curb edge of an intersection

Pedestrian Crossovers:

- 15 metres of a pedestrian crossover located prior to an intersection
- 9 metres of pedestrian crossover located beyond the approaching intersection

Driveways/Laneways:

- 1.0 metres approaching or beyond a driveway or laneway

TTC Stops:

- 30 metres approaching a transit stop
- 18 metres beyond a transit stop

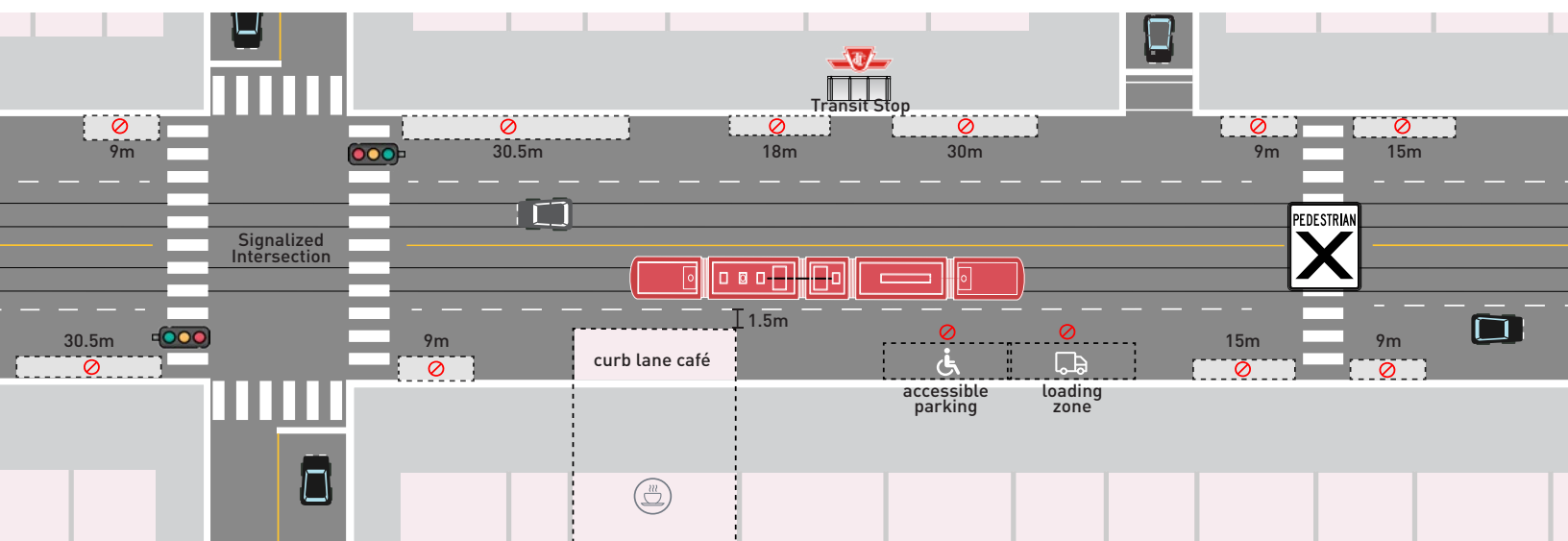

TEMPORARY ACCESSIBLE PLATFORMS

Temporary accessible platforms are placed in the curb lane to provide a raised, step-free sidewalk-level mobility and seating surface for café patrons. Temporary accessible platforms are required to ensure the CaféTO program meets the City of Toronto's goals and objectives to create a City that is accessible to all. Temporary accessible platforms also increase the aesthetic appeal of curb lane cafés, increase safety for cyclists, and provide a sense of comfort for diners.

Temporary platforms are only permitted to be installed during the café season and must be removed before the scheduled curb lane café removal date. Operators are responsible for the disassembly, removal and storage of the platform, at their own cost, in the event of emergency capital or utility work, as directed by the General Manager of Transportation Services, or their delegate.

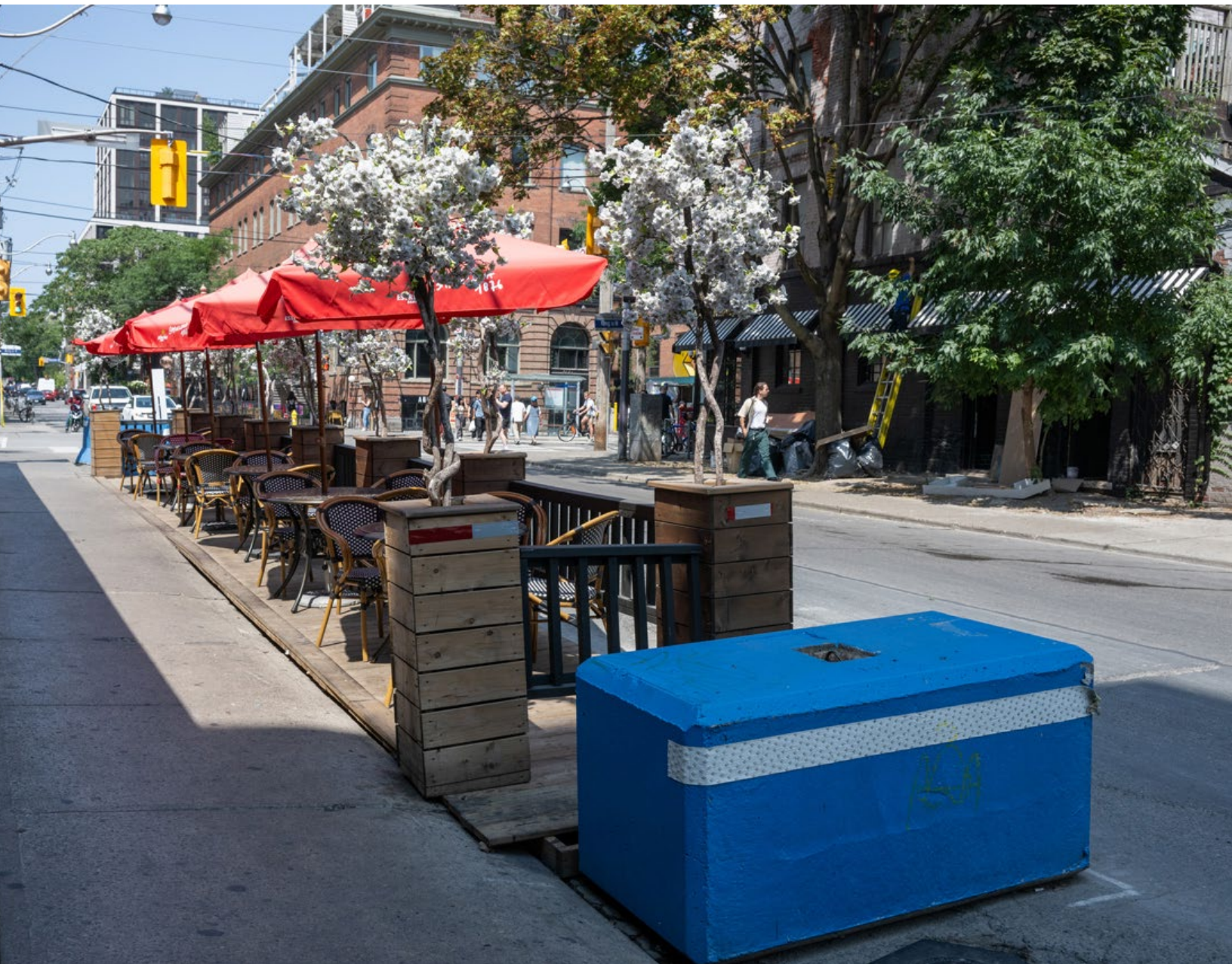

TEMPORARY ACCESSIBLE PLATFORM DESIGN GUIDELINES

1. The platform must be signed/stamped by an engineer, architect or BCIN licensed designer to meet Ontario Building Code requirements, and ensure the safety and integrity of the design.
2. Platforms must not exceed the café space allocated to you by the CaféTO program.
3. Platforms may not be affixed to the roadway, sidewalk, or attached to any utilities, street trees or sidewalk elements.
4. In order to ensure space for cyclists, the perimeter of the platform, including the vertical barrier, must provide a minimum 1.2 metres clearance (1.5 metres on streets with streetcar service) away from the travelling path of vehicular traffic.
5. Platforms may not be placed over in-ground utilities, such as storm drains, hydro vaults, maintenance covers, hand wells etc., unless:
 - a. A design solution has been agreed upon in writing with CaféTO staff; and
 - b. Special permissions have been granted by the utility company in writing.

NOTE: Required clearances from utilities and infrastructure can be found in [Chapter 742](#), and the [Utility and Infrastructure Clearance Table](#).

6. Platforms must provide the required clearances from all other in-ground and above ground utilities and street furniture to permit maintenance activities, or any other alternative set-back or clearance requirement as determined by City staff.
7. Platforms must provide a 1.2 metres clearance from any fire hydrant or fire connection.
8. Platforms should be designed to allow storm water flow and drainage.
9. As part of the vertical barrier, opaque items (including dense plant material) must not be greater than 1.2 metres in height, measured from the surface of the street, to preserve sight lines.
10. No roofs, roof supports, retractable roofing, pergolas, arches, trellises, tents, or tent-like structures are permitted, whether constructed of rigid or pliable materials, including any decorative items.
11. Fabric, canvas, plexiglass or similar materials are not to be used for the vertical barrier.
12. Platforms must have retro-reflective tape, or reflective flexi-posts at each end of the café area, and preferably along the full length of the closure area. All other materials must minimize glare for nighttime road users. Reflective items are widely available for purchase at hardware stores.
13. Approved locations must meet all curb lane closure requirements and must be installed within the design of the closure area.
14. Platforms, furniture and all café elements must not encroach on the sidewalk without a valid curbside sidewalk café permit.

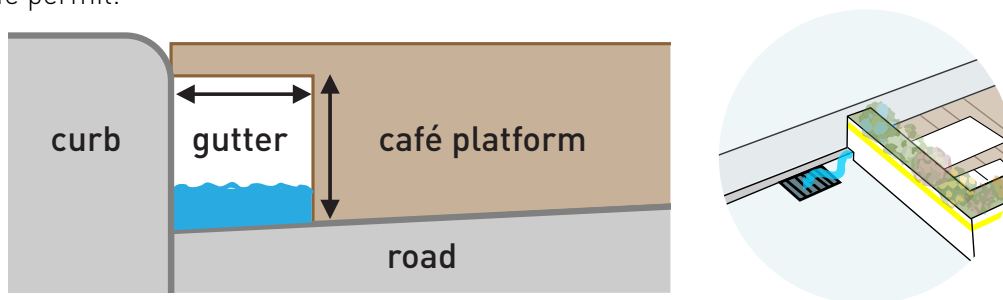

Drainage Diagram: Temporary platforms should be designed to include a gap space under the platform surface to facilitate stormwater flow and drainage.



TEMPORARY ACCESSIBLE PLATFORM DESIGN DRAWING TECHNICAL CHECKLIST

All plans must be accurate, legible and drawn to scale using metric measurements.

Temporary Platform plan:

- The plan view of the platform must show the outer edges and the dimensions (width and depth) and indicate the curb line
- The cycling offset dimension between the proposed platform and the live lane of traffic must be included (this dimension will be provided to you on your Traffic Plan for reference)
- Indicate all in-ground utilities within the proposed permit area, and utilities within 2.0 metres from the edge of the platform on all sides (e.g. maintenance hole, catch basin, hand-well valve)
- If any utilities are within the permit area, or do not meet the required clearances in the and the **Utility and Infrastructure Clearance Table**, you must indicate the design solution (e.g. access hatch), or provide in writing, supplementary special permission from the utility company
- Include all identifying information such as the address of your business

Elevation drawing(s):

- Designs must demonstrate a secure, stable, and safe vertical barrier along the perimeter of the curb lane café, except between the curb lane café and sidewalk
- The elevation view must demonstrate the platform surface is level with the sidewalk
- The overall height of the vertical barrier must be dimensioned from the surface of the road and be a minimum of 1.2 metres, with no opaque parts of the barrier exceeding 1.2 metres (e.g. sparse plants are acceptable above 1.2 metres, solid fencing or decorative materials are not acceptable)
- One 1.0 metre wide emergency access point in the exterior vertical barrier for every curb lane café (an access point is an easily identifiable sections of the vertical barrier that can be easily removed in an emergency)

AND

An additional 1.0 metre access point for every 15.0 metres of continuous fencing (if your curb lane café exceeds 15.0 metres, two emergency access points are required)

- Designed so that fire hydrants and fire department connections are visible and easily accessible

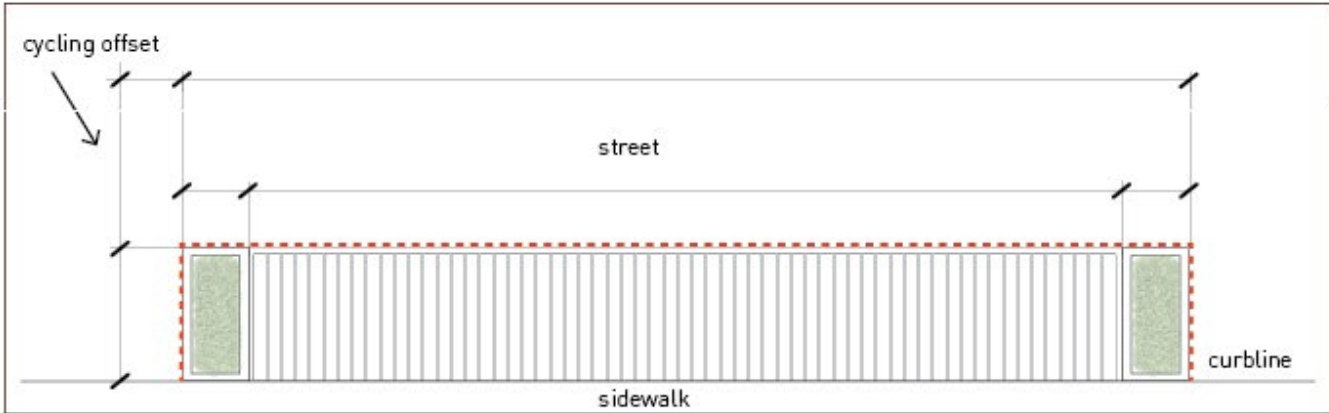

Platform Plan

Name of Restaurant:

Address:

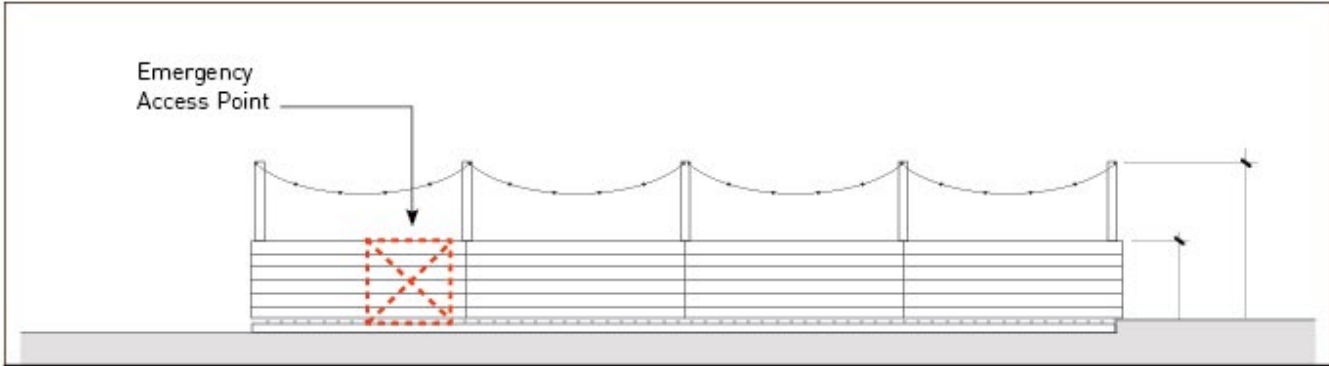

Platform Elevation

Name of Restaurant:

Address:

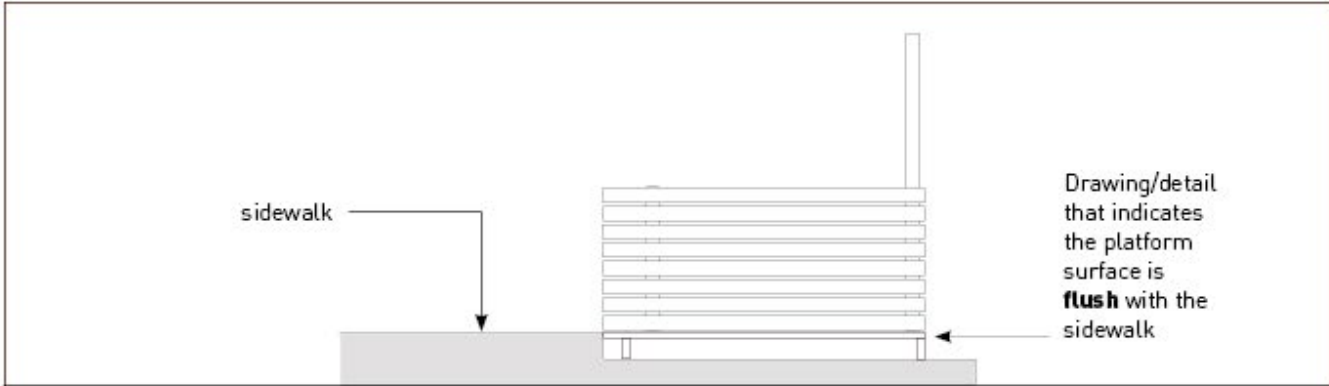

Platform Elevation

Name of Restaurant:

Address:



CAFÉ ALIGNMENT

The permitted length of your curb lane café will depend on the following:

1. Your business is within a BIA which is participating in the Curb Lane Program:

- The length of your curb lane café will be determined in partnership with your BIA

2. Your business is within a BIA which is not participating in the Curb Lane Pilot Program:

- Your curb lane café may be the length of your business frontage, or less if requested in your initial application

3. Your business is not within a BIA:

- Your curb lane café may be the length of your business frontage, or may extend beyond your frontage up to 12 metres (whichever is greater)
- You may request more or less than your business frontage in your initial application
- Permission letters are not required from adjacent landlords or tenants to extend your curb lane café beyond your frontage

IMPORTANT!

The area of your curb lane café will determine your seasonal permit fees, measured per square metre. The width of your curb lane café will be determined by the City, and provided to you; and if you apply to extend your curb lane café beyond your frontage, your feasibility review may require additional assessment and time to confirm your permit area.

UMBRELLAS AND CANOPIES

Umbrellas and canopies are a source of shade for café patrons and employees, and must be installed correctly to ensure the safety of customers and passers-by. Please ensure all umbrellas and canopies meet the following guidelines:

- Canopies are temporary and removable with no walls or sides.
- The fabric of the umbrella or canopy must be at least 2.1 metres above the level of the street.
- Canopies may be 3.0m x 3.0m (10' x 10') or smaller. They must be located entirely within the curb lane café and not encroach on the sidewalk or roadway.
- All umbrella parts in a curb lane café must be set back at least 0.8 metres from either edge of the closure area.
- Umbrellas and canopies must not protrude into the roadway, as they may interfere with cyclists or vehicles passing in close proximity to your café.
- Umbrellas and canopies must be properly weighted down to prevent being blown over by wind.
- Umbrellas and canopies must be removed from the curb lane during inclement weather or high winds so that they do not create a safety hazard.
- Umbrellas and canopies must be installed so that there are no issues with sightlines for motorists.
- Structures and tent installations are not permitted in curb lane cafés.

EMERGENCY ACCESS

To ensure adequate curbside access for emergency services, ALL curb lane cafés must have a minimum of one 1.0 metre wide emergency access point in the fixed vertical barrier for every temporary platform/permit area, and an additional 1.0 metre wide access point when a vertical barrier exceeds 15 metres.

An emergency access point is a 1.0 metre wide space with an easily identifiable and removable piece of the vertical barrier, which allows quick access from the road to the sidewalk for emergency services personnel. An example of an emergency access point could be removable wooden boards suspended by brackets, stanchions, a section of vertical barrier without rebar/reinforcement or other solutions as approved by City staff.





5.0 ACCESSIBILITY AND CURB LANE CAFÉS

It is important to consider accessibility when designing all aspects of your café area. Your establishment must adhere to the following accessibility standards:

- Ensure that you maintain barrier-free access and sidewalk clearance for people using mobility devices, especially when considering the placement of your café equipment and customer queuing areas;
- Provide an accessible entrance to your café with a minimum width of 1 metre;
- It is the responsibility of the business owner to comply with the [Accessibility for Ontarians with Disabilities Act](#) (AODA) at all times; and
- If it is found that your café does not have an accessible entrance and temporary accessible platform in accordance with these guidelines, enforcement action may be taken. Repeat complaints may result in a removal of café permissions.

Barrier-free Design

Barrier-free, accessible, universal and inclusive design describe a space that may be approached, entered and used by a person with physical or sensory disabilities.

PEDESTRIAN CLEARWAY

Ensuring accessibility for CaféTO includes meeting requirements from the Accessibility for Ontarians with Disabilities Act (AODA), City of Toronto accessibility requirements and accessibility criteria specific to the CaféTO program. All accessibility requirements are equally important and together they create a CaféTO program that is accessible to all Torontonians.

The pedestrian clearway is a continuous straight path of sidewalk, clear of all obstructions and is the most important area of the sidewalk for the safe, accessible and efficient movement of pedestrians. The sidewalk is how people and customers of all ages and abilities access local shops, restaurants, offices, transit stops and other services, and pedestrians have the first priority for its use. It is everyone's responsibility to protect the pedestrian clearway.

The pedestrian clearway requires 2.1m of space on most sidewalks, with certain wider sidewalks in the downtown core requiring 2.5m. A list of streets requiring a 2.5m wide pedestrian clearway is available on page 41 of [Chapter 742](#).

ONLINE ACCESSIBILITY RESOURCES:

[Accessibility for Ontarians with Disabilities Act](#)

[AODA Requirements for Businesses and Non-Profits with 20-49 Workers](#)

[AODA Requirements for Businesses and Non-Profits with 1-19 Workers](#)

[Toronto Accessibility Design Guidelines](#)

**Pedestrian Clearway Checklist:**

- Do not place café materials in the pedestrian clearway
- Ensure your café's delineation has a solid base that is detectable for someone using a white cane
- Do not use the pedestrian clearway to queue patrons awaiting their reservation or table
- Do not place A-frame signs or other obstacles in the pedestrian clearway
- Do not lay electrical wires for any appliances (e.g. heaters, lights) across the pedestrian clearway
- Do not encroach onto the sidewalk with extended platforms, furniture, fencing, planters, server stations or hostess stands



CAFÉ FURNITURE AND FACILITIES

There are many ways to make a café space more accessible and comfortable for everyone. Please consider the following when making decisions about your café elements:

- Consider people using mobility devices when determining what type of furniture you set out in your café area. For example, picnic tables significantly limit the ability of a person using a mobility device to access a dining surface.
- When determining seating arrangements in your café area, install some tables with room underneath to accommodate people using mobility devices.
- Ensure that there are clear routes and maneuvering spaces for people using mobility devices in your café.
- Advertise whether you have accessible washrooms on your website.
- Provide accessible tactile signage with braille to indicate seating areas, paths, washrooms, and payment/assistance counters.
- The vertical barrier surrounding the café should incorporate a significant colour contrast from the street or surroundings.
- Provide a platform surface that is a different colour/texture to any surrounding sidewalk or pathway to make it distinct and easy to identify.
- Provide chairs and tables that contrast with their surroundings to make them easier to see and find.

TEMPORARY RAMPS

If you choose to operate your café before your temporary platform is installed, a ramp into your café **MUST BE PROVIDED**. Temporary ramps are fabricated ramps that provide a sloped entrance from the sidewalk into the curb lane café area.

A temporary ramp should be in place at all times when your café is open and operational; it should not be deployed “as needed”. When obtaining and installing your ramp, ensure that the following requirements are met:

- The ramp must be at least 1.0 metre wide
- The ramp must have a slip-proof surface and be visible at night
- The ramp must be stable so that it does not shift or move when used
- There must be space at the bottom of the ramp for someone using a mobility device to turn and navigate into the café area

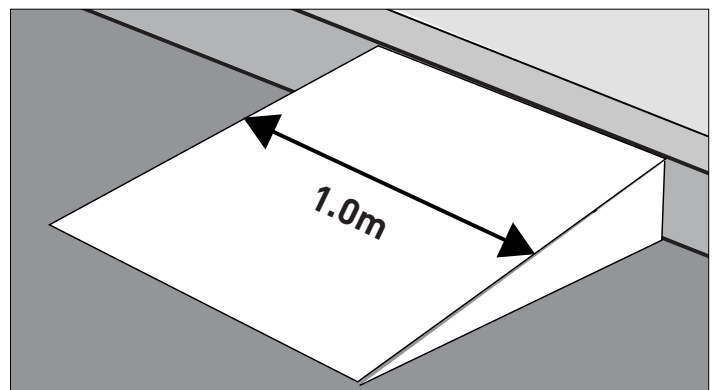



6.0 GENERAL REQUIREMENTS AND OPERATOR RESPONSIBILITIES

Lighting

Installing lighting elements can be an important benefit to your café area in the evening. Please ensure your lighting elements comply with the following guidelines:

- Lighting features must be temporary and comply with all applicable safety standards and codes.
- Ensure no power cables or lighting elements run over the pedestrian clearway. Consider battery or solar powered lights.
- Lights must not cast glare for pedestrians, passing road users or nearby properties
- Lights cannot be attached to trees, utilities or other street elements.
- Permission has been granted for your power source if it is not your own

Amplified Music and Noise

The City of Toronto's **Amplified Live Music** on Patios program runs for the duration of the CaféTO season. The program allows amplified live music on CaféTO patios to add energy and vitality to participating main streets – and helps local artists.

- Ensure that noise arising from the service of food and alcohol on your outdoor café, including the conduct of your patrons, does not disturb local residents
- Noise and live music must comply with Chapter 591 – Noise and other City and Provincial statutes, bylaws, regulations, orders and guidelines
- Amplified live music performances are only permitted between the hours of:
 - 5:00 p.m. to 10:00 p.m. on Thursday or Friday;
 - noon to 10:00 p.m. on Saturday; and
 - noon to 6:00 p.m. on Sunday.
- Amplified live music is not permitted on local roads

Maintenance, Cleanliness and Orderliness

- The curb lane, sidewalk and any other street areas around curb lane cafés must be kept in a clean and sanitary condition
- The café area must be clear of debris and trip or slip hazards (e.g., cigarette butts, spilled food or liquids)
- All dining furniture, platforms, fencing and planters are maintained in good repair
- Ensure that patrons are not smoking or vaping in the café area, or within a nine metre radius of the perimeter of the café area.
- No café elements are to be mounted on or within hard surface street tree openings, panels or grates.
- Outdoor carpeting, artificial turf or other surface covering is not permitted on any portion of the sidewalk or street.

Fire and Utility Access

- Curb lane cafés must maintain unobstructed emergency access routes and existing facilities conforming to the Ontario Building Code and the Fire Code.
- A 1.2 metres clearance must be maintained between fixed vertical elements (e.g. fencing) and all fire hydrants or fire connections at all times.
- Fire hydrants or fire connection must be visible from the street and accessible at all times for Fire Services.
- You must allow City officials and other utility providers to access their assets for use or maintenance, including removing café elements, at your expense, if required.

Waste Collection

- Restaurants and bars that receive night time waste collection from the City of Toronto should continue to place their bins at curbside on your regular collection night
- If a curb lane closure prevents you from placing your bins in front of your establishment, place them communally with your neighbours 3 metres away from the end of the closure area, away from bike lanes and preferably under a streetlight, if possible.
- Ensure your location's address is on your bins.

Use of Café Space

- Curb lane cafés must be opened within 30 days of traffic safety equipment being deployed and operate at least three (3) times a week.

Heating Devices and Fire Safety

- Fueled outdoor heaters may be placed within curb lane cafés provided the manufacturer's specifications are met and Toronto Fire Services guidelines for placing, storing, and operating them in outdoor dining spaces are followed.
- Operators must ensure that all fire protection equipment is being maintained as per Ontario Fire Code regulations. More information about the safe operation of portable heaters is available in the **Appendix on page 25**
- Open-air fires, fire pits, or cooking devices (including BBQs) are not allowed within the public right-of-way

Hours of Operation

Cafés in the curb lane on main streets may serve alcohol until 2:00 a.m., and must be vacated by 2:45 a.m., unless the operator has a condition imposed on their establishment from Community Council or the **AGCO** that requires them to close earlier, or unless alternate hours of operation have been imposed under provincial regulations. Curb lane cafés on local roads must be vacated by 11:00 p.m. unless alternate hours of operation have been imposed by Community Council or under provincial regulations.

Removal Authority

The City may take enforcement action under Articles 13 and/or 14 of Chapter 742 and, in addition, may immediately remove any café type at the expense of the operator without reporting to Community Council where, in the opinion of the General Manager of Transportation Services, the café does not comply with these guidelines, Chapter 742, other applicable bylaws (e.g. City of Toronto Municipal Code Chapter 591 (Noise)) or other municipal or provincial orders or regulations or the past conduct of the applicant gives the City reason to believe they will not operate in accordance with the law.

APPENDIX

TORONTO FIRE SERVICES PORTABLE HEATER GUIDELINES

Your portable heating appliance must:

- Be certified by CSA/ULC
- Meet the requirements of TSSA Act 2000
- Be designed for outdoor use only
- Have an anti-tilt feature that automatically shuts off the heater
- Be free-standing, with a minimum height of 160 cm (65 inches)

NOTE: Table top heating appliances are not permitted

DO install your portable heating appliance:

- On a non-combustible solid surface (e.g. not on grass or uneven sidewalk)
- With a minimum of 1.0 metre (3.0 feet) clearance from the base of the unit to any combustible material

DO NOT install your portable heating appliance:

- In windy conditions. Wind negatively impacts efficiency and can create a hazard if the unit is blown over
- Under fire escapes
- Near a combustible structure
- Adjacent to or otherwise obstructing firefighting equipment like fire hydrants or connections
- Within the Tree Protection Zone of any trees. For more information or to request an exception, please contact your district Tree Protection and Plan Review office
- Near or attached to any utilities or other street elements
- If electrical wires need to be placed on the pedestrian clearway

FUELED HEATING APPLIANCES

If you choose to use a propane or other fueled heating appliance, please follow these specific safety guidelines:

- Do not store the unit indoors
- Keep a maximum of one day's supply of propane on site
- Storage of additional cylinders (including cylinders in cages) is not permitted in public thoroughfares or sidewalks)
- The maximum allowable propane tank size is a single 9 kg (20 lb) tank (approximately 10 hours of operation)
- Do not move portable heaters while the flame is still open. Ensure the gas supply is properly shut off and the unit is cool before relocating

TORONTO HYDRO REQUIREMENTS

Examples of Toronto Hydro structures and equipment



Cable Chamber

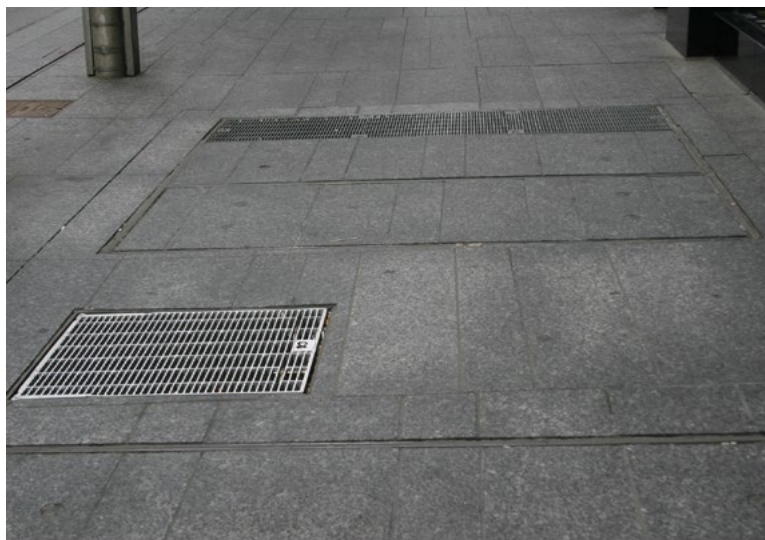

Hydro Vault



Padmount Transformer or Switchgear



Distribution/Street Lighting Pole

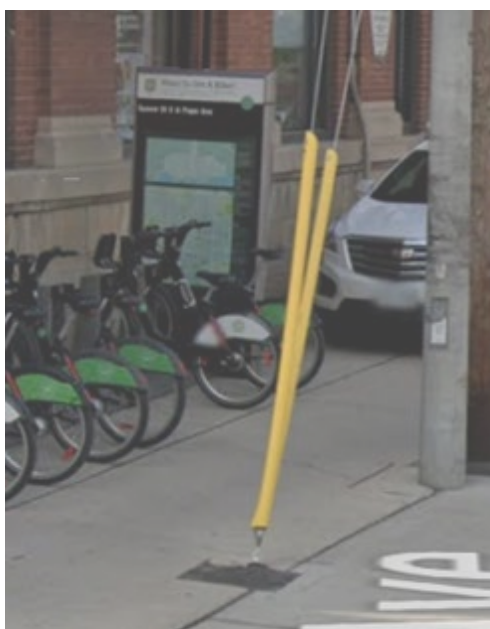

Guy Wire/Anchor

CAREFULLY REVIEW THIS INFORMATION AND ENSURE THAT YOUR CAFÉ MATERIALS ARE PLACED THE APPROPRIATE DISTANCE FROM TORONTO HYDRO STRUCTURES AND EQUIPMENT.

Notes:

- CaféTO participants will generally need to follow the set-back guidelines for "Temporary Café Elements" as no equipment should be affixed to any element in the right-of way
- Cable chambers, distribution poles and street lighting poles are very common and include BIA street lighting elements

UTILITY & INFRASTRUCTURE CLEARANCES

Utility or Infrastructure Element (Measured from edge of element/utility)	Required Clearance	
	Temporary fixed elements	Temporary portable elements
Hydro Infrastructure		
Cable Chamber*	2.0 metres	0.3 metre
Hydro Vault*	1.0 metre	1.0 metre
Transformer/Switchgear*	3.0 metres	3.0 metres
Distribution Pole	0.6 metre	0.3 metre
Street Lighting Pole [^]	0.6 metre	0.3 metre
Guy wire/anchor	0.6 metre	0.3 metre
BIA lighting access hatch [^]	0.3 metre	0.3 metre
Traffic Infrastructure		
Traffic signal pole	0.3 metre for local street or 1.0 metre	0.3 metre
Traffic control box	1.5 metres from front, sides 0.6 metre	0.3 metre
Traffic or parking sign pole	0.3 metre	0.3 metre
Fire Services & Water Infrastructure		
Fire Hydrant*	1.2 metres	1.2 metres
Fire Standpipe Connection*	1.2 metres	1.2 metres
Water Valve (post indicator/isolation)	0.6 metre	0.3 metre
Catch basin ^{^^}	0.6 metre	0.3 metre
Storm/Sanitary maintenance access covers	0.6 metre	0.3 metre
Gas Infrastructure		
Gas valve (and other assets)	2.0 metres	0.3 metre

- Street furniture or utility listed without any asterisk (*[^]) may be located within proposed permit area if approved by the City [^] or other clearance as determined by the local BIA for BIA owned lighting infrastructure
- ^{^^} must be measured as a minimum linear distance along the curb edge; and for transit stops/shelters must have a minimum 2.4m width for the transit platform area where transit riders get on/off
- *must be measured as a minimum radius width from the street element or utility
- ** clearance may be less if approved by the City taking into consideration streetscape context and other bike parking facilities in the immediate area
- *** café elements must not be placed on open soil or soft surfaces adjacent to street trees, nor be fixed to the tree pit surface, so Urban Forestry has full access
- **** intersections and pedestrian crossovers require adequate space for people of all ages and abilities waiting to cross the street and for safety and visibility. Additional separation distances are required for curbside and curb lane cafés for visibility and road safety

UTILITY & INFRASTRUCTURE CLEARANCES

Utility or Infrastructure Element (Measured from edge of element/utility)	Required Clearance	
	Temporary fixed elements	Temporary portable elements
Telecom Infrastructure		
In-ground access covers	2.0 metres	0.3 metre
Above-ground access unit	1.0 metres	0.3 metre
Public Realm Infrastructure		
Street Furniture (bench, litter bin, newspaper corral, postering column)*	1.0 metre	1.0 metre
Transit shelter: with advertising^^	5.0 metres	5.0 metres
Transit shelter: without advertising^^	2.5 metres	2.5 metres
Transit stop poles^^	2.5 metres	2.5 metres
Wayfinding columns*	3.0 metres	3.0 metres
Wayfinding sign poles*	1.0 metre	1.0 metre
Bicycle locking ring**	2.5 metres	2.5 metres
Bike Share station^^	1.0 metre	1.0 metre
Toronto Parking Authority ticket kiosk*	1.0 metre	1.0 metre
Tress and Horticulture		
Street tree* and***	1.0 metre	0.3 metre
Above and in-ground planters***	1.0 metre	0.3 metre
Pedestrian Safety		
Intersection or Pedestrian Crossover****	3.0 metres	3.0 metres

- Street furniture or utility listed without any asterisk [*^] may be located within proposed permit area if approved by the City ^ or other clearance as determined by the local BIA for BIA owned lighting infrastructure
- ^^ must be measured as a minimum linear distance along the curb edge; and for transit stops/shelters must have a minimum 2.4m width for the transit platform area where transit riders get on/off
- *must be measured as a minimum radius width from the street element or utility
- ** clearance may be less if approved by the City taking into consideration streetscape context and other bike parking facilities in the immediate area
- *** café elements must not be placed on open soil or soft surfaces adjacent to street trees, nor be fixed to the tree pit surface, so Urban Forestry has full access
- **** intersections and pedestrian crossovers require adequate space for people of all ages and abilities waiting to cross the street and for safety and visibility. Additional separation distances are required for curbside and curb lane cafés for visibility and road safety

THE CAFÉTO TEAM

CITY DIVISIONS

Economic Development and Culture: The Economic Development and Culture Division strives to make Toronto a place where business and culture thrive. The division's objective is to advance Toronto's prosperity, opportunity and liveability by fostering employment and investment opportunities, encouraging Toronto's cultural vibrancy through more and enhanced cultural experiences and engaging partners in the planning and development of the City's economic and cultural resources.

The team members from the Economic Development and Culture liaise directly with local BIAs and businesses to ensure the CaféTO program supports the economic and cultural needs of unique neighbourhoods and communities.

Transportation Services: Transportation Services plans, constructs and manages the transportation infrastructure within the public right-of-way, including the public realm, sidewalks and roads. The Division's vision is to provide a safe, efficient, and effective transportation system that serves Toronto residents, businesses, and visitors in an environmentally, socially and economically sustainable manner.

The team members from the Transportation Services division plan and review the feasibility and traffic safety requirements for each curb lane café. Our operational teams manage and deploy traffic safety equipment, City-wide.

PARTNERS

Business Improvement Areas (BIA): A Business Improvement Area (BIA) is an association of commercial property owners and tenants within a defined area who work in partnership with the City to create thriving, competitive, and safe business areas that attract shoppers, diners, tourists, and new businesses. By working collectively as a BIA, local businesses have the organizational and funding capacity to be catalysts for civic improvement, enhancing the quality of life in their local neighbourhood and the City as a whole.

BIAs are an integral part of the CaféTO program. The CaféTO team and BIAs work together to support the unique streetscapes and community within a BIA, striking a balance between the needs of local businesses, residents and the CaféTO program. If your restaurant or bar is located within a BIA, you should speak to your BIA representative for additional information and assistance. Please find the list of BIAs [here](#).

CaféTO

CURB LANE CAFÉ GUIDELINES 2025, VERSION 1.0

